

**From:** Truong, Cassie <TruongC@metro.net>  
**Sent time:** 06/01/2020 04:24:16 PM  
**To:** mindy.nguyen@lacity.org  
**Subject:** DevReview: ENV-2018-2115-EIR  
**Attachments:** 200110\_MAD\_Handbook\_FINAL\_COMPRESSED.pdf 200601\_Hollywood Center.pdf

---

Greetings,

Thank you for the opportunity to comment on the Hollywood Center Project located at 1720-1724 North Vine Street in the City of LA. Attached are Metro's comments. Please kindly reply to confirm receipt.

Please contact Shine Ling at 213.922.2671 or devreview@metro.net if you have any questions.

Best,

**Cassie Truong**

LA Metro

Transportation Associate

Transit Oriented Communities

213.418.3489

[metro.net](http://metro.net) | [facebook.com/losangelesmetro](https://www.facebook.com/losangelesmetro) | [@metrolosangeles](https://twitter.com/metrolosangeles)

**Metro's mission is to provide world-class transportation for all.**

Los Angeles County  
Metropolitan Transportation Authority

# METRO ADJACENT DEVELOPMENT HANDBOOK

A GUIDE FOR CITIES AND DEVELOPERS

JANUARY 2020



Metro

# Metro and Regional Rail Map

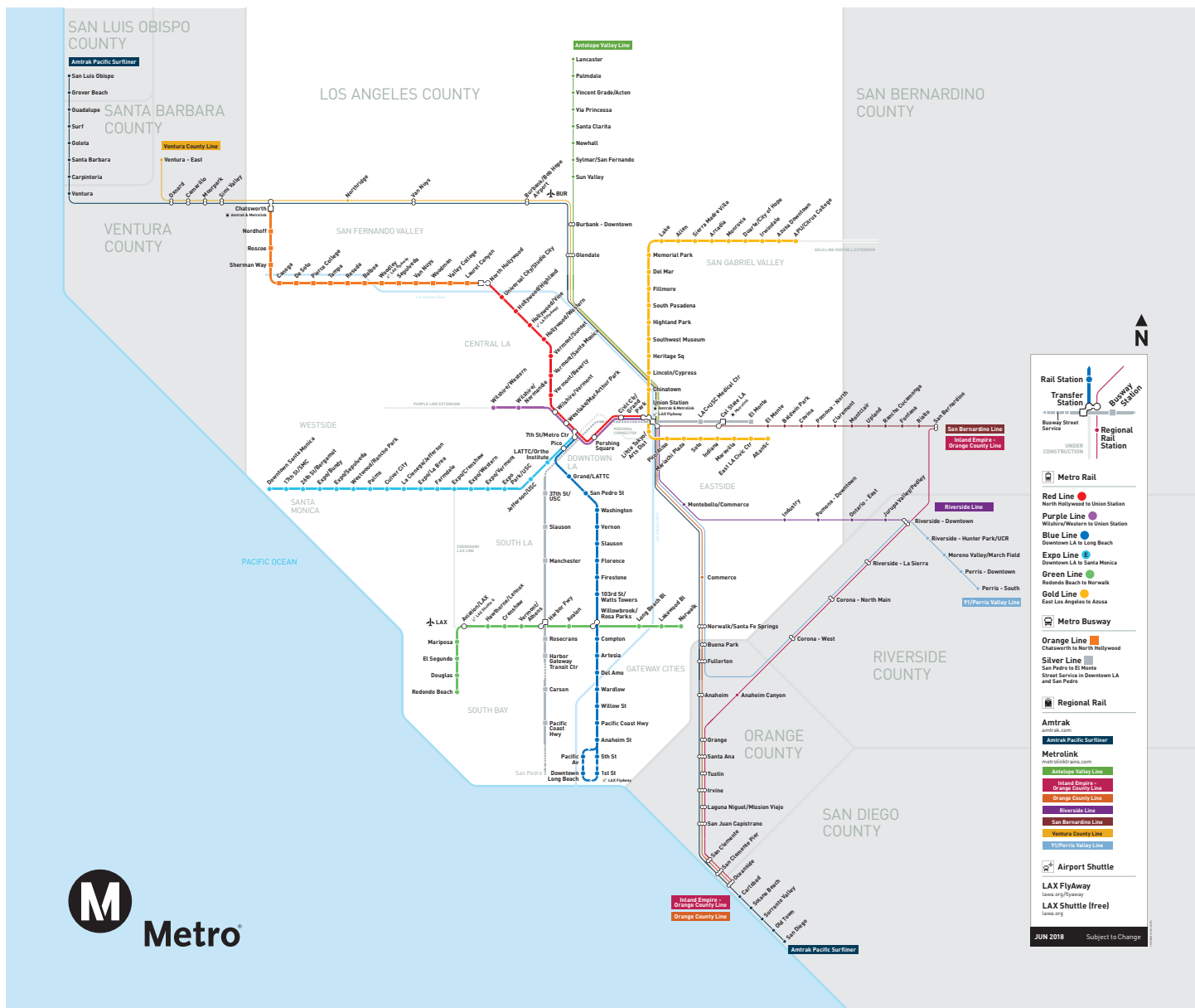

Metro is currently undertaking the largest rail infrastructure expansion effort in the United States. A growing transit network presents new opportunities to catalyze land use investment and shape livable communities.

## Table of Contents

|   |           |
|---|-----------|
| <b>Quick Overview</b>                           | <b>1</b>  |
| Background                                      | 2         |
| Metro Purview & Concerns                        | 4         |
| Metro Coordination Process                      | 6         |
| Best Practices                                  | 8         |
| <br>  |           |
| <b>1. Site Plan &amp; Conceptual Design</b>     | <b>11</b> |
| 1.1 Supporting Transit Oriented Communities     | 12        |
| 1.2 Enhancing Access to Transit                 | 13        |
| 1.3 Building Setback                            | 14        |
| 1.4 Overhead Catenary System (OCS) Clearance    | 15        |
| 1.5 Shared Barrier Construction & Maintenance   | 16        |
| 1.6 Project Orientation & Noise Mitigation      | 17        |
| 1.7 At-Grade Rail Crossings                     | 18        |
| 1.8 Sight-lines at Crossings                    | 19        |
| 1.9 Driveway/Access Management                  | 20        |
| 1.10 Bus Stop & Zones Design                    | 21        |
| <br>  |           |
| <b>2. Engineering &amp; Technical Review</b>    | <b>23</b> |
| 2.1 Excavation Support System Design            | 24        |
| 2.2 Proximity to Tunnels                        | 25        |
| 2.3 Protection from Explosion/Blast             | 26        |
| <br>  |           |
| <b>3. Construction Safety &amp; Management</b>  | <b>29</b> |
| 3.1 Pre-Construction Coordination               | 30        |
| 3.2 Track Access and Safety                     | 31        |
| 3.3 Construction Hours                          | 32        |
| 3.4 Excavation/Drilling Monitoring              | 33        |
| 3.5 Crane Operations                            | 34        |
| 3.6 Construction Barriers & Overhead Protection | 35        |
| 3.7 Pedestrian & Emergency Access               | 36        |
| 3.8 Impacts to Bus Routes & Stops               | 37        |
| 3.9 Utility Coordination                        | 38        |
| 3.10 Air Quality & Ventilation Protection       | 39        |
| <br>  |           |
| <b>Glossary</b>                                 | <b>40</b> |



REGINA TUNNELING CORPORATION  
SIANGKA TUBUKI

# Quick Overview

## Purpose of Handbook

The Metro Adjacent Development Handbook (Handbook) is intended to provide information and guide coordination for projects adjacent to, below, or above Metro transit facilities (e.g. right-of-way, stations, bus stops) and services.

### Overarching Goal

By providing information and encouraging early coordination, Metro seeks to reduce potential conflicts with transit services and facilities, and identify potential synergies to expand mobility and improve access to transit.

### Intended Audience

The Handbook is a resource for multiple stakeholder groups engaged in the development process, including:

- Local jurisdictions who review, entitle, and permit development projects,
- Developers,
- Property owners,
- Architects, engineers, and other technical consultants,
- Builders/contractors,
- Utility companies, and
- other Third Parties.

### Handbook Content

The Handbook includes:

- **Introduction** of Metro's Development Review coordination process, common concerns, and typical stages of review.
- **Information** on best practices during three key coordination phases to avoid potential conflicts or create compatibility with the Metro transit system:
  - Planning & Conceptual Design,
  - Engineering & Technical Review, and
  - Construction Safety & Monitoring.
- **Glossary** with definitions for key terms used throughout the Handbook.

## RULE OF THUMB: 100 FEET

**Metro's Development Review process applies to projects that are within 100 feet of Metro transit facilities.**

While the Handbook summarizes key concerns and best practices for adjacency conditions, it does not replace Metro's technical requirements and standards.

**Prior to receiving approval for any construction activities adjacent to, above, or below Metro facilities, Third Parties must comply with the Metro Adjacent Construction Design Manual, available on Metro's website.**

### Contact Us

For questions, contact the Development Review Team:

- Email: [devreview@metro.net](mailto:devreview@metro.net)
- Phone: 213.418.3484

### Additional Information & Resources

- Metro Development & Construction Coordination website:  
<https://www.metro.net/devreview>
- Metro GIS/KML ROW Files:  
<https://developer.metro.net/portfolio-item/metro-right-of-way-gis-data>
- Metrolink Standards and Procedures:  
<https://www.metrolinktrains.com/about/agency/engineering--construction>

Metro will continue to revise the Handbook, as needed, to reflect updates to best practices in safety, operations, and transit-supportive development.

## Who is Metro?

The Los Angeles County Metropolitan Transportation Authority (Metro) plans, funds, builds, and operates rail, bus, and other mobility services (e.g. bikeshare, microtransit) throughout Los Angeles County (LA County). On average, Metro moves 1.3 million people each day on buses and trains. With funding from the passage of Measure R (2008) and Measure M (2016), the Metro system is expanding. Over the next 40 years, Metro will build over 60 new stations and over 100 miles of transit right-of-way (ROW). New and expanded transit lines will improve mobility across LA County, connecting riders to more destinations and expanding opportunities for development that supports transit ridership. Metro facilities include:



**Metro Rail:** Metro operates heavy rail (HRT) and light rail (LRT) transit lines in underground tunnels, along streets, off-street in dedicated ROW, and above street level on elevated structures. Heavy rail trains are powered by a “third rail” along the tracks. Light rail vehicles are powered by overhead catenary systems (OCS). To support rail operations, Metro owns and maintains traction power substations (TPSS), maintenance yards, and other infrastructure.



**Metrolink/Regional Rail:** Metro owns a majority of the ROW within LA County on which the Southern California Regional Rail Authority (SCRRA) operates Metrolink service. Metrolink is a commuter rail system with seven lines that span 388 miles across five counties, including: Los Angeles, Orange, Riverside, San Bernardino, Ventura, and North San Diego. As a SCRRA member agency and property owner, Metro reviews development activity adjacent to Metro-owned ROW on which Metrolink operates, and coordinates with Metrolink on any comments or concerns. Metrolink has its own set of standards and processes, see link on page 1.



**Metro Bus Rapid Transit (BRT):** Metro operates accelerated bus transit, which acts as a hybrid between rail and traditional bus service. Metro BRT may operate in a dedicated travel lane within a street or freeway, or off-street along dedicated ROW. Metro BRT stations may be located on sidewalks within the public right-of-way, along a median in the center of streets, or off-street on Metro-owned property.



**Metro Bus:** Metro operates 170 bus lines across more than 1,400 square miles in LA County. The fleet serves over 15,000 bus stops with approximately 2,000 buses. Metro operates “Local” and “Rapid” bus service within the street, typically alongside vehicular traffic, though occasionally in “bus-only” lanes. Metro bus stops are typically located on sidewalks within the public right-of-way, which is owned and maintained by local jurisdictions.

## Why is Metro interested in adjacent development?

**Metro Supports Transit Oriented Communities:** Metro is redefining the role of the transit agency by expanding mobility options, promoting sustainable urban design, and helping transform communities throughout LA County. Metro seeks to partner with local, state, and federal jurisdictions, developers, property owners and other stakeholders across LA County on transit-supportive planning and developments to grow ridership, reduce driving, and promote walkable neighborhoods. Transit Oriented Communities (TOCs) are places (such as corridors or neighborhoods) that, by their design, allow people to drive less and access transit more. TOCs maximize equitable access to a multi-modal transit network as a key organizing principle of land use planning and holistic community development.

**Adjacent Development Leads to Transit Oriented Communities:** Metro supports private development adjacent to transit as this presents a mutually beneficial opportunity to enrich the built environment and expand mobility options. By connecting communities, destinations, and amenities through improved access to public transit, adjacent developments have the potential to:

- reduce auto dependency,
- reduce greenhouse gas emissions,
- promote walkable and bikeable communities that accommodate more healthy and active lifestyles,
- improve access to jobs and economic opportunities, and
- create more opportunities for mobility – highly desirable features in an increasingly urbanized environment.

**Opportunity:** Acknowledging an unprecedented opportunity to influence how the built environment develops along and around transit and its facilities, Metro has created this document. The Handbook helps ensure compatibility between private development and Metro's transit infrastructure to minimize operational, safety, and maintenance issues. It serves as a crucial first step to encourage early and active collaboration with local stakeholders and identify potential partnerships that leverage Metro initiatives and support TOCs across LA County.





# Metro Purview & Concerns

## Metro Purview for Review & Coordination

**Metro is interested in reviewing development, construction, and utility projects within 100 feet of Metro transit facilities, real estate assets, and ROW** – as measured from the edge of the ROW outward – both to ensure the structural safety of existing or planned transit infrastructure and to maximize integration opportunities with adjacent development. The Handbook seeks to:

- Improve communication and coordination between developers, jurisdictions, and Metro.
- Identify common concerns associated with developments adjacent to Metro ROW.
- Highlight Metro operational needs and requirements to ensure safe, continuous service.
- Prevent potential impacts to Metro transit service or infrastructure.
- Maintain access to Metro facilities for riders and operational staff.
- Avoid preventable conflicts resulting in increased development costs, construction delays, and safety impacts.
- Streamline the review process to be transparent, clear, and efficient.
- Assist in the creation of overall marketable and desirable developments.

### Key Audiences for Handbook

The Handbook is intended to be used by:

- Local jurisdictions who review, entitle, and permit development projects and/or develop policies related to land use, development standards, and mobility,
- Developers, property owners,
- Architects, engineers, design consultants,
- Builders/contractors,
- Entitlement consultants,
- Environmental consultants,
- Utility companies, and
- other Third Parties.

### Metro Assets & Common Concerns for Adjacent Development

The table on the facing page outlines common concerns for development projects and/or construction activities adjacent to Metro transit facilities and assets. These concerns are discussed in greater detail in the following chapters of the Handbook.

## METRO ASSETS

## COMMON ADJACENCY CONCERNS

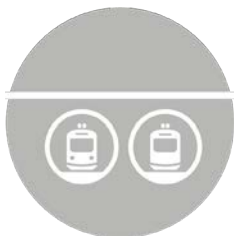

### UNDERGROUND ROW

Transit operates below ground in tunnels.

- Excavation near tunnels and infrastructure
- Clearance from support structures (e.g. tiebacks, shoring, etc)
- Coordination with utilities
- Clearance from ventilation shafts, surface penetrations (e.g. emergency exits)
- Surcharge loading of adjacent construction
- Explosions
- Noise and vibration/ground movement
- Storm water drainage

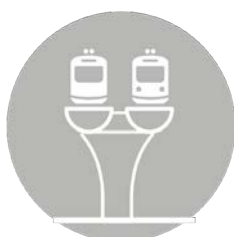

### AERIAL ROW

Transit operates on elevated guideway, typically supported by columns.

- Excavation near columns and support structures
- Column foundations
- Clearance from OCS
- Overhead protection and crane swings
- Setbacks from property line for maintenance activities to occur without entering ROW
- Coordination with utilities
- Noise reduction (e.g. double-paned windows)



### AT-GRADE ROW

Transit operates in dedicated ROW at street level; in some cases tracks are separated from adjacent property by fence or wall.

- Pedestrian and bicycle movements and safety
- Operator site distance/cone of visibility
- Clearance from OCS
- Crane swings and overhead protection
- Trackbed stability
- Storm water drainage
- Noise/vibration
- Driveways near rail crossings
- Setbacks from property line for maintenance activities to occur without entering ROW
- Utility coordination



### BUS STOPS

Metro operates bus service on city streets. Bus stops are located on public sidewalks.

- Lane closures and re-routing service during construction
- Temporary relocation of bus stops
- Impacts to access to bus stops



### NON-REVENUE/OPERATIONAL

Metro owns and maintains property to support operations (e.g. bus and rail maintenance facilities, transit plazas, traction power substations, park-and-ride parking lots).

- Excavation and clearance from support structures (e.g. tiebacks, shoring, etc)
- Ground movement
- Drainage
- Utility coordination
- Access to property

# Metro Coordination Process

## Typical Stages of Metro Review and Coordination

Early coordination helps avoid conflicts between construction activities and transit operations and maximizes opportunities to identify synergies between the development project and Metro transit services that are mutually beneficial.



**Coordination Goal:** Metro encourages developers to consult with the Development Review Team early in the design process to ensure compatibility with transit infrastructure and minimize operational, safety, and maintenance issues with adjacent development. The Development Review team will serve as a case manager to developers and other Third Parties to facilitate the review of plans and construction documents across key Metro departments.

**Level of Review:** Not all adjacent projects will require significant review and coordination with Metro. The level of review depends on the Project's proximity to Metro, adjacency conditions, and the potential to impact Metro facilities and/or services. For example, development projects that are excavating near Metro ROW or using cranes near transit facilities require a greater level of review and coordination. Where technical review and construction monitoring is needed, Metro charges fees for staff time, as indicated by asterisk in the above diagram.

**Permit Clearance:** Within the City of Los Angeles, Metro reviews and clears Building & Safety permits for projects within 100 feet of Metro ROW, pursuant to [Zoning Information 1117](#). To ensure timely clearance of these permits, Metro encourages early coordination as noted above.

To begin consultation, submit project information via an online [In-Take Form](#), found on Metro's website. Metro staff will review project information and drawings to screen the project for any potential impacts to transit facilities or services, and determine if require further review and coordination is required. The sample sections on the facing page illustrate adjacency condition information that helps Metro complete project screening.

### Contact:

Metro Development Review Team  
Website: <https://www.metro.net/devreview>  
Email: [devreview@metro.net](mailto:devreview@metro.net)  
Phone: 213.418.3484

## Sample Section: Adjacency Conditions

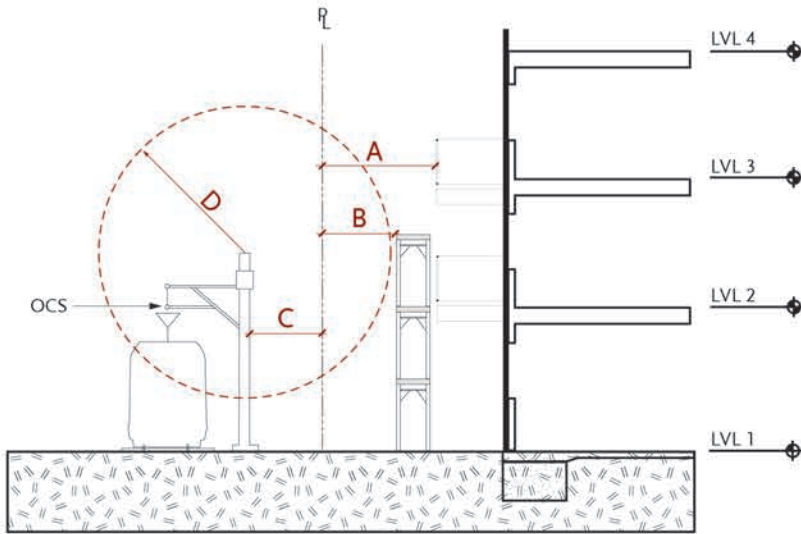

**AT-GRADE CONDITION**

A. Distance from property line to nearest permanent structure (e.g. building facade, balconies, terraces). Refer to Section 1.3 Building Setback of Handbook.

B. Distance from property line to nearest temporary construction structures (e.g. scaffolding).

C. Distance from property line to nearest Metro facility.

D. Clearance from nearest temporary and/or permanent structure to Overhead Catenary System (OCS). Refer to Section 1.4, OCS Clearance of Handbook.

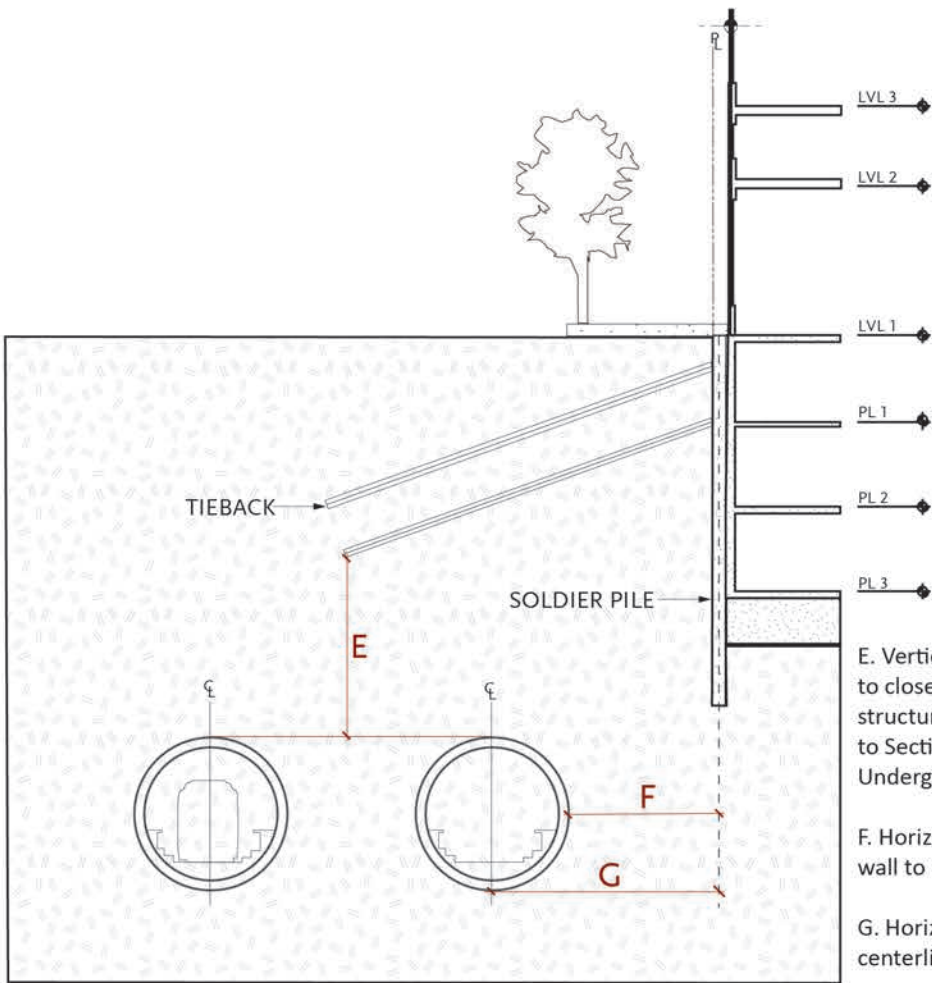

**BELOW-GRADE CONDITION**

E. Vertical distance from top of Metro tunnel to closest temporary and/or permanent structure (e.g. tiebacks, foundation). Refer to Section 2.2, Proximity to Tunnels & Underground Infrastructure of Handbook.

F. Horizontal distance from exterior tunnel wall to nearest structure.

G. Horizontal distance from Metro track centerline to nearest structure.

## Best Practices for Developer Coordination

Metro encourages developers of projects adjacent to Metro ROW and/or Real Estate Assets to take the following steps to facilitate Metro project review and approval:

1. **Review Metro resources and policies:** The Metro Development & Construction Coordination website and Handbook provide important information for those interested in constructing on, adjacent, over, or under Metro ROW, non-revenue property, or transit facilities. Developers and other Third Parties should familiarize themselves with these resources and keep in mind common adjacency concerns when planning a project.
2. **Contact Metro early during design process:** Metro welcomes the opportunity to provide feedback early in project design, allowing for detection and resolution of important adjacency issues, identification of urban design and system integration opportunities, and facilitation of permit approval. Metro encourages project submittal through the online [In-Take Form](#) to begin consultation.
3. **Maintain communication:** Frequent communication with Metro during project design and construction will reinforce relationships and allow for timely project completion.

## Best Practices for Local Jurisdiction Notification

To improve communication between Metro and the development community, Metro suggests that local jurisdictions take the following steps to notify property owners of coordination needs for properties adjacent to Metro ROW by:

- **Updating GIS and parcel data:** Integrate Metro ROW files into the City/County GIS and/or Google Earth Files for key departments (e.g. Planning, Public Works, Building & Safety) to notify staff of Metro adjacency and need for coordination during development approval process.
- **Flag Parcels:** Create an overlay zone as part of local Specific Plan(s) and/or Zoning Ordinance(s) to tag parcels that are within 100 feet Metro ROW and require coordination with Metro early during the development process [e.g. City of Los Angeles Zone Information and Map Access System (ZI-1117)].
- **Provide Resources:** Direct all property owners and developers interested in parcels within 100 feet of Metro ROW to Metro's resources (e.g. website, Handbook).



M

Metro

Downtown  
Santa  
Monica

E



# Site Plan & Conceptual Design



# Site Plan & Conceptual Design

## 1.1 Supporting Transit Oriented Communities

Transit-oriented communities (TOCs) are places that, by their design, make it more convenient to take transit, walk, bike or roll than to drive. By working closely with the development community and local jurisdictions, Metro seeks to ensure safe construction near Metro facilities and improve compatibility with adjacent development to increase transit ridership.

**RECOMMENDATION:** Consider site planning and building design strategies to that support transit ridership, such as:

- Leveraging planning policies and development incentives to design a more compelling project that capitalizes on transit adjacency and economy of scales.
- Programming a mix of uses to create lively, vibrant places that are active day and night.
- Utilizing Metro policies and programs that support a healthy, sustainable, and welcoming environment around transit service and facilities.
- Prioritizing pedestrian-scaled elements to create spaces that are comfortable, safe, and enjoyable.
- Activating ground floor with retail and outdoor seating/activities to bring life to the public environment.
- Reducing and screening parking to focus on pedestrian activity.
- Incorporating environmental design elements that help reduce crime (e.g. windows and doors that face public spaces, lighting).



*The Wilshire/Vermont Metro Joint Development project leveraged existing transit infrastructure to catalyze a dynamic and accessible urban environment. This project accommodates portal access into the Metro Rail system and on-street bus facilities.*



## 1.2 Enhancing Access to Transit

Metro seeks to create a comprehensive, integrated transportation network and supports infrastructure and design that allows safe and convenient access to its multi-modal services. Projects in close proximity to Metro's services and facilities present an opportunity to enhance the public realm and connections to/from these services for transit riders as well as users of the developments.

**RECOMMENDATION:** Design projects with transit access in mind. Project teams should capitalize on the opportunity to improve the built environment and enhance the public realm for pedestrians, bicyclists, persons with disabilities, seniors, children, and users of green modes. Metro recommends that projects:

- Orient major entrances to transit service, making access and travel safe, intuitive, and convenient.
- Plan for a continuous canopy of shade trees along all public right-of-way frontages to improve pedestrian comfort to transit facilities.
- Add pedestrian lighting along paths to transit facilities and nearby destinations.
- Integrate wayfinding and signage into project design.
- Enhance nearby crosswalks and ramps.
- Ensure new walkways and sidewalks are clear of any obstructions, including utilities, traffic control devices, trees, and furniture.
- Design for seamless, multi-modal pedestrian connections, making access easy, direct, and comfortable.



*The City of Santa Monica leveraged investments in rail transit and reconfigured Colorado Avenue to form a multi-modal first/last mile gateway to the waterfront from the Downtown Santa Monica Station. Photo by PWP Landscape Architecture*

## 1.3 Building Setback

Buildings and structures with a zero lot setback that closely abut Metro ROW can pose concerns to Metro during construction. Encroachment onto Metro property to construct or maintain buildings is strongly discouraged as this presents safety hazards and may disrupt transit service and/or damage Metro infrastructure.

**RECOMMENDATION:** Include a minimum setback of five (5) feet from the property line to building facade to accommodate the construction and maintenance of structures without the need to encroach upon Metro property. As local jurisdictions also have building setback requirements, new developments should comply with the greater of the two requirements.

Entry into the ROW by parties other than Metro and its affiliated partners requires written approval. Should construction or maintenance of a development necessitate temporary or ongoing access to Metro ROW, a Metro Right of Entry Permit must be requested and obtained from Metro Real Estate for every instance access is required. Permission to enter the ROW is granted solely at Metro's discretion.

Coordination between property owners of fences, walls, and other barriers along property line is recommended. See Section 1.5.

Refer to Section 3.2 – Track Access and Safety for additional information pertaining to ROW access in preparation for construction activities.

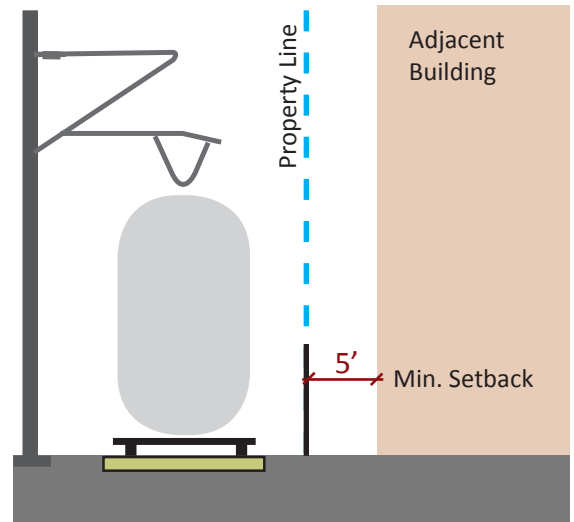

*A minimum setback of five (5) feet between an adjacent structure and Metro ROW is strongly encouraged to allow project construction and ongoing maintenance without encroaching on Metro property.*



## 1.4 Overhead Catenary System (OCS) Clearance

Landscaping and tree canopies can grow into the OCS above light rail lines, creating electrical safety hazards as well as visual and physical impediments for trains. Building appurtenances facing rail ROW, such as balconies, may also pose safety concerns to Metro operations as objects could fall onto the OCS.

**RECOMMENDATION:** Design project elements facing the ROW to avoid potential conflicts with Metro transit vehicles and infrastructure. Metro recommends that projects:

- Plan for landscape maintenance from private property and prevent growth into Metro ROW. Property owners will not be permitted to access Metro property to maintain private development.
- Design buildings such that balconies do not provide building users direct access to Metro ROW.
- Maintain building appurtenances and landscaping at a minimum distance of ten (10) feet from the OCS and support structures. If Transmission Power (TP) feeder cable is present, twenty (20) feet from the OCS and support structures is required. Different standards will apply for Metro Trolley Wires, Feeder Cables (wires) and Span Wires.

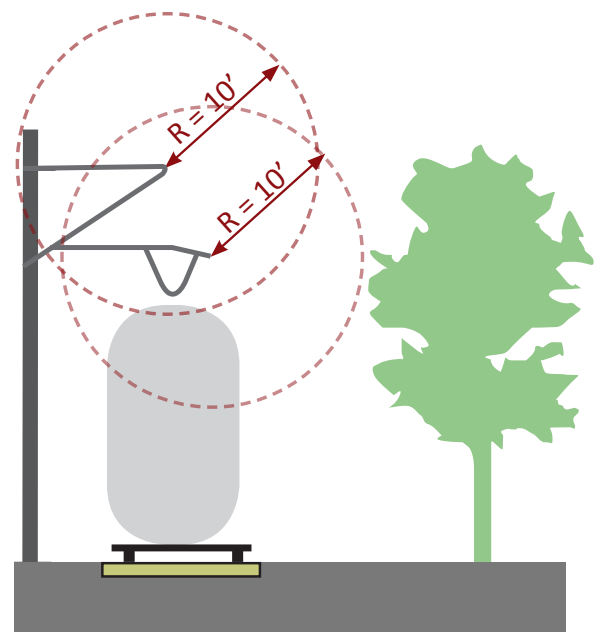

*Adjacent structures and landscaping should be sited and maintained to avoid conflicts with the rail OCS.*

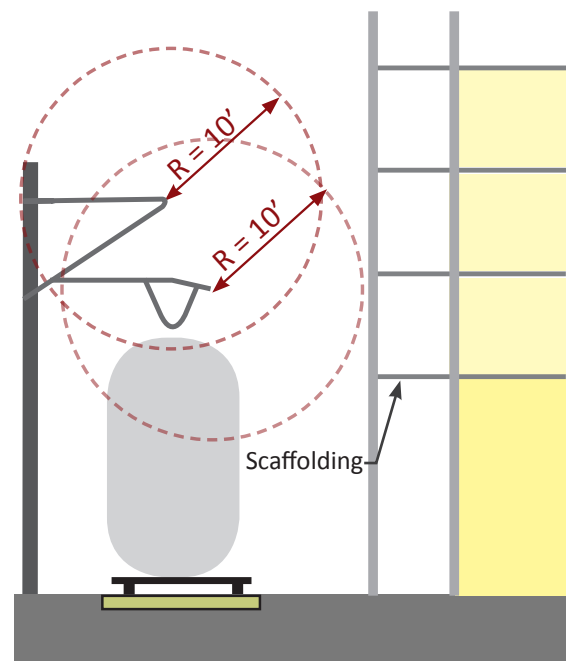

*Scaffolding and construction equipment should be staged to avoid conflicts with the rail OCS.*

# Site Plan & Conceptual Design

## 1.5 Shared Barrier Construction & Maintenance

In areas where Metro ROW abuts private property, barrier construction and maintenance responsibilities can be a point of contention with property owners. When double barriers are constructed, the gap created between the Metro-constructed fence and a private property owner's fence can accumulate trash and make regular maintenance challenging without accessing the other party's property.

**RECOMMENDATION:** Coordinate with Metro Real Estate to create a single barrier condition along the ROW property line. With an understanding that existing conditions along ROW boundaries vary throughout LA County, Metro recommends the following, in order of preference:

- **Enhance existing Metro barrier:** if structural capacity allows, private property owners and developers should consider physically affixing improvements onto and building upon Metro's existing barrier. Metro is amenable to barrier enhancements such as increasing barrier height and allowing private property owners to apply architectural finishes to their side of Metro's barrier.
- **Replace existing barrier(s):** if conditions are not desirable, remove and replace any existing barrier(s), including Metro's, with a new single "shared" barrier built on the property line.

Metro is amenable to sharing costs for certain improvements that allow for clarity in responsibilities and adequate ongoing maintenance from adjacent property owners without entering Metro's property. Metro Real Estate should be contacted with case-specific questions and will need to approve shared barrier design, shared financing, and construction.

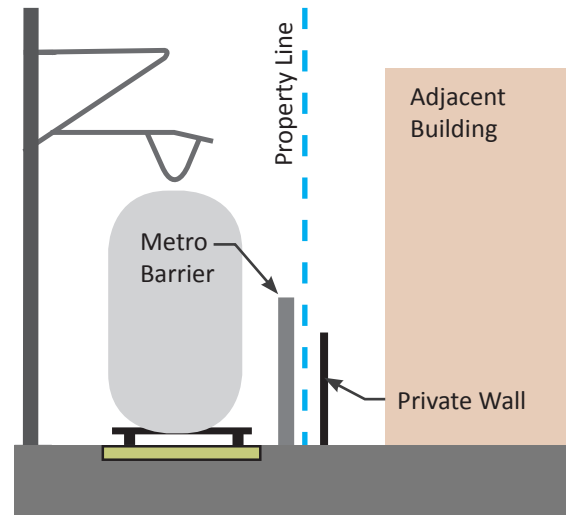

*Double barrier conditions allow trash accumulation and create maintenance challenges for Metro and adjacent property owners.*

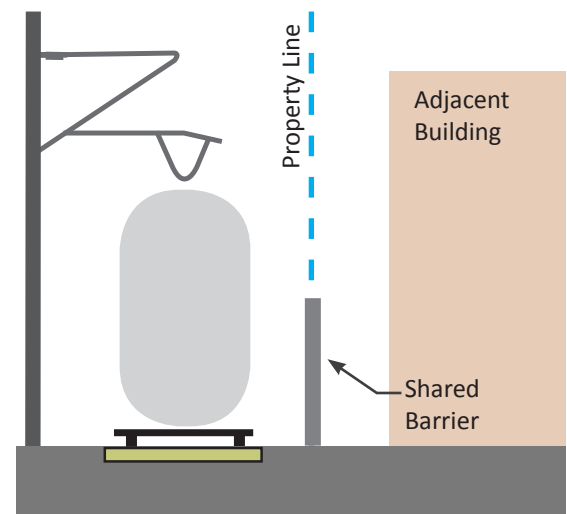

*Metro prefers a single barrier condition along its ROW property line.*



## 1.6 Project Orientation & Noise Mitigation

Metro may operate in and out of revenue service 24 hours per day, every day of the year, which can create noise and vibration (i.e. horns, power washing). Transit service and maintenance schedules cannot be altered to avoid noise for adjacent developments. However, noise and vibration impacts can be reduced through building design and orientation.

**RECOMMENDATION:** Use building orientation, programming, and design techniques to reduce noise and vibration for buildings along Metro ROW:

- Locate secondary or “back of house” rooms (e.g. bathrooms, stairways, laundry rooms) along ROW, rather than primary living spaces that are noise sensitive (e.g. bedrooms and family rooms).
- Use upper level setbacks and locate living spaces away from ROW.
- Enclose balconies.
- Install double-pane windows.
- Include language disclosing potential for noise, vibration, and other impacts due to transit proximity in terms and conditions for building lease or sale agreements to protect building owners/sellers from tenant/buyer complaints.

Developers are responsible for any noise mitigation required, which may include engineering designs for mitigation recommended by Metro or otherwise required by local municipalities. A recorded Noise Easement Deed in favor of Metro may be required for projects within 100 feet of Metro ROW to ensure notification to tenants and owners of any proximity issues.

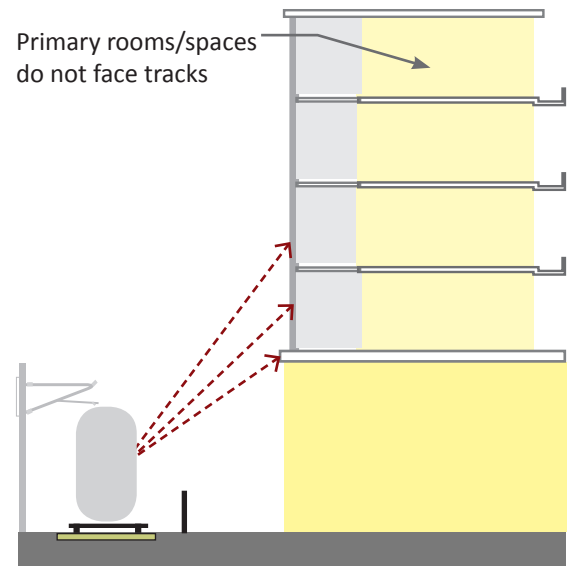

*Building orientation can be designed to face away from tracks, reducing the noise and vibration impacts.*

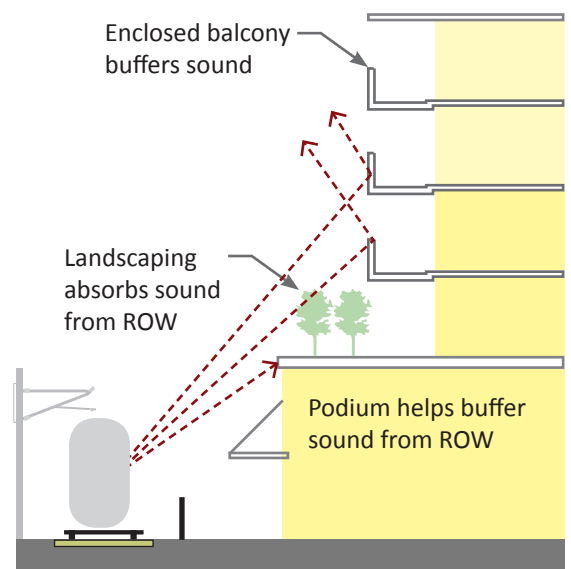

*Strategic placement of podiums and upper-level setbacks on developments near Metro ROW can reduce noise and vibration impacts.*

# Site Plan & Conceptual Design

## 1.7 At-Grade Rail Crossings

New development is likely to increase pedestrian activity at rail crossings. Safety enhancements may be needed to upgrade existing rail crossings to better protect pedestrians.

**RECOMMENDATION:** Coordinate with Metro, the California Public Utilities Commission (CPUC), and any other transit operators using the crossing (e.g. Metrolink) to determine if safety enhancements are needed for nearby rail crossings.

While Metro owns and operates the rail ROW, the CPUC regulates all rail crossings. Contact the CPUC early in the design process to determine if they will require any upgrades to existing rail crossings. The CPUC may request to review development plans and hold a site visit to understand future pedestrian activity. Metro's Corporate Safety Department can support the developer in coordination with the CPUC.



*Gates and pedestrian arms are common types of safety elements for pedestrians at rail crossings.*



## 1.8 Sight-lines at Crossings

Developments adjacent to Metro ROW can present visual barriers to transit operators approaching vehicular and pedestrian crossings. Buildings and structures in close proximity to transit corridors can reduce sight-lines and create blind corners where operators cannot see pedestrians. This requires operations to reduce train speeds, which decreases efficiency of transit service.

**RECOMMENDATION:** Design buildings to maximize transit service sight-lines at crossings, leaving a clear cone of visibility to oncoming vehicles and pedestrians.

Metro Rail Operations will review, provide guidance, and determine the extent of operator visibility for safe operations. If the building envelope overlaps with the visibility cone near pedestrian and vehicular crossings, a building setback may be necessary to ensure safe transit service. The cone of visibility at crossings and required setback will be determined based on vehicle approach speed.



Limited sight-lines for trains approaching street crossings create unsafe conditions.

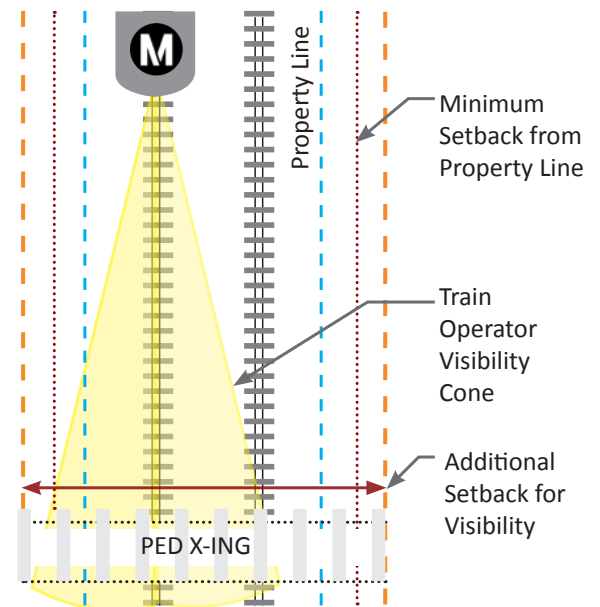

Visibility cones allow train operators to respond to safety hazards.



## 1.9 Driveway/Access Management

Driveways adjacent to on-street bus stops can create conflict for pedestrians walking to/from or waiting for transit. Additionally, driveways accessing parking lots and loading zones at project sites near Metro Rail and BRT crossings can create queuing issues along city streets and put vehicles in close proximity to fast moving trains and buses, which pose safety concerns.

**RECOMMENDATION:** Site driveways and other vehicular entrances to avoid conflicts with pedestrians, bicycles, and transit vehicles by:

- Placing driveways along side streets and alleys, away from on-street bus stops and transit crossings to minimize safety conflicts between active ROW, transit vehicles, and people, as well as queuing on streets.
- Locating vehicular driveways away from transit crossings or areas that are likely to be used as waiting areas for transit services.
- Placing loading docks away from sidewalks where transit bus stop activity is/will be present.
- Consolidating vehicular entrances and reduce width of driveways.
- Using speed tables to slow entering/exiting automobiles near pedestrians.
- Separating pedestrian walkways to minimize conflict with vehicles.
- Encouraging safe non-motorized travel.



*Driveways in close proximity to each other compromise safety for those walking to/from transit and increase the potential for vehicle-pedestrian conflicts.*



## 1.10 Bus Stop & Zones Design

Metro Bus serves over 15,000 bus stops throughout the diverse landscape that is LA County. Typically located on sidewalks within public right-of-way owned and maintained by local jurisdictions, existing bus stop conditions vary from well-lit and sheltered spaces to uncomfortable and unwelcoming zones. Metro is interested in working with developers and local jurisdictions to create a vibrant public realm around new developments by strengthening multi-modal access to/from Metro transit stops and enhancing the pedestrian experience.

**RECOMMENDATION:** When designing around existing or proposed bus stops:

- Review Metro’s Transit Service Policy, which provides standards for design and operation of bus stops and zones for near-side, far-side, and mid-block stops.
- Review Metro’s Transfers Design Guide for more information at <https://www.metro.net/projects/station-design-projects/>
- Accommodate 5’ x 8’ landing pads at bus doors (front and back door, which are typically 23 to 25 feet apart).
- Locate streetscape elements (e.g. tree planters, street lamps, benches, shelters, trash receptacles and newspaper stands) outside of bus door zones to protect transit access and ensure a clear path of travel.
- Install a concrete bus pad within each bus stop zone to avoid street asphalt damage.
- Replace stand-alone bus stop signs with bus shelters that include benches and adequate lighting.
- Design wide sidewalks (15’ preferred) that accommodate bus landing pads as well as street furniture, landscape, and user travel space.
- Consider tree species, height, and canopy shape (higher than 14’ preferred) to avoid vehicle conflicts at bus stops. Trees should be set back from the curb and adequately maintained to prevent visual and physical impediments for buses when trees reach maturity. Avoid planting of trees that have an invasive and shallow root system.

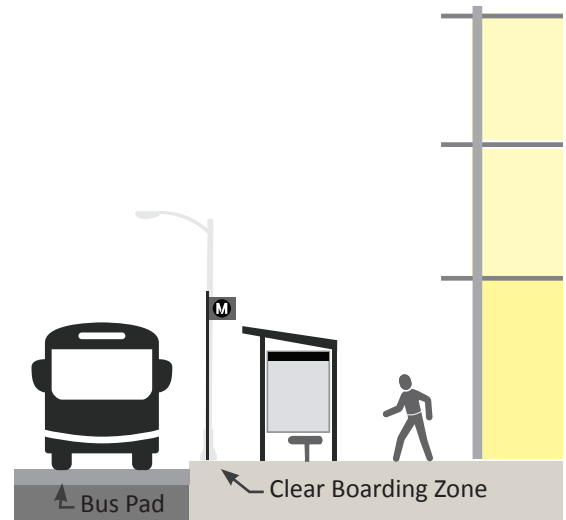

*A concrete bus pad should be located at bus stops and bus shelters should be located along sidewalks to ensure an accessible path of travel to a clear boarding area.*

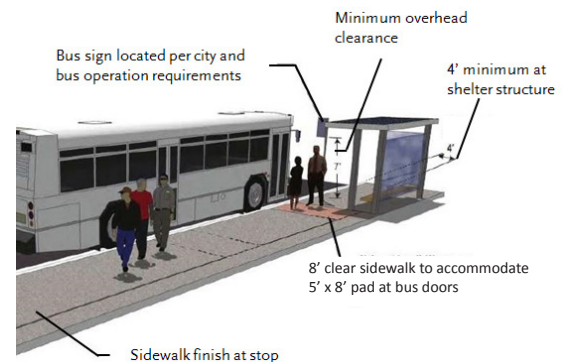

*Well-designed and accessible bus stops are beneficial amenities for both transit riders and users of adjacent developments.*

**GORBEL 2.5**  
DANGER DO NOT EXCEED RATED CAPACITY





# Engineering & Technical Review

## 2.1 Excavation Support System Design

Excavation near Metro ROW has the potential to disturb adjoining soils and jeopardize support of existing Metro infrastructure. Any excavation which occurs within the geotechnical foul zone relative to Metro infrastructure is subject to Metro review and approval and meet Cal/OSHA requirements. This foul zone or geotechnical zone of influence shall be defined as the area below a track-way as measured from a 45-degree angle from the edge of the rail track ballast. Construction within this vulnerable area poses a potential risk to Metro service and requires additional Metro Engineering review.

**RECOMMENDATION:** Coordinate with Metro Engineering staff for review and approval of the excavation support system drawings and calculations prior to the start of excavation or construction. Tiebacks encroaching into Metro ROW may require a tieback easement or license, at Metro's discretion.

Any excavation/shoring within Metrolink operated and maintained ROW will require compliance with SCRRRA Engineering standards and guidelines.

See page 7 for a sample section showing Metro adjacent conditions.

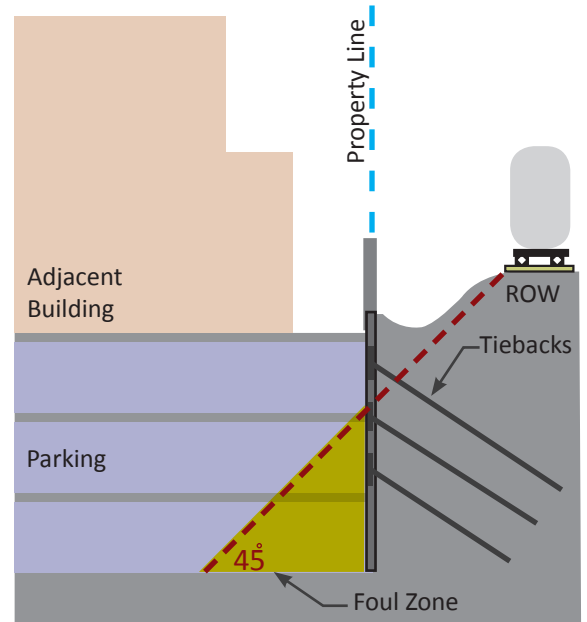

*An underground structure located within the ROW foul zone would require additional review by Metro.*



## 2.2 Proximity to Tunnels & Underground Infrastructure

Construction adjacent to, over, or below underground Metro facilities (tunnels, stations and appendages) is of great concern and should be coordinated closely with Metro Engineering.

**RECOMMENDATION:** Coordinate with Metro early in the design process when proposing to build near underground Metro infrastructure. Metro typically seeks to maintain a minimum eight (8) foot clearance from existing Metro facilities to new construction (shoring or tiebacks). It will be incumbent upon the developer to demonstrate, to Metro’s satisfaction, that both the temporary support of construction and the permanent works do not adversely affect the structural integrity, safety, or continued efficient operation of Metro facilities.

Dependent on the nature of the adjacent construction, Metro will need to review the geotechnical report, structural foundation plans, sections, shoring plan sections and calculations.

Metro may require monitoring where such work will either increase or decrease the existing overburden (i.e. weight) to which the tunnels or facilities are subjected. When required, the monitoring will serve as an early indication of excessive structural strain or movement. See Section 3.4, Excavation Drilling/Monitoring for additional information regarding monitoring requirements.

See page 7 for a sample section showing Metro adjacent conditions.

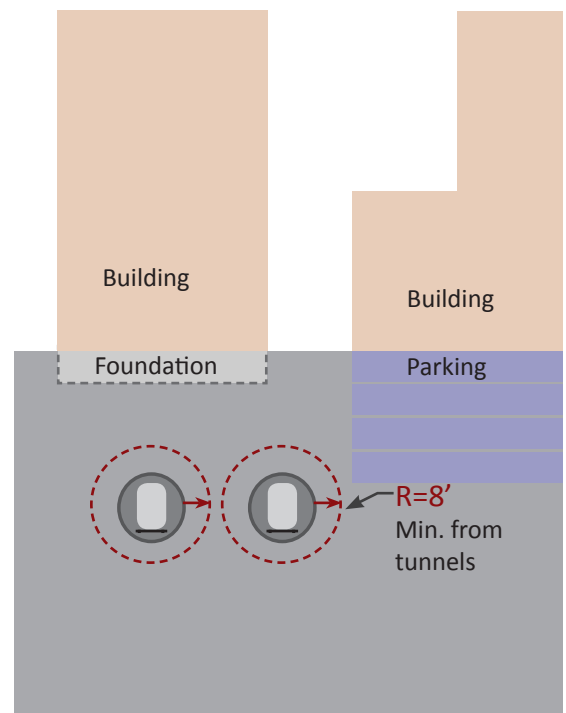

*Adjacent project structures in close proximity to underground Metro infrastructure will require additional review by Metro.*

## 2.3 Protection from Explosion/Blast

Metro is obligated to ensure the safety of public transit infrastructure from potential explosive sources which could originate from adjacent underground structures or from at-grade locations, situated below elevated guideways or near stations. Blast protection setbacks or mitigation may be required for large projects constructed near critical Metro facilities.

**RECOMMENDATION:** Avoid locating underground parking or basement structures within twenty (20) feet from an existing Metro tunnel or facility (exterior face of wall to exterior face of wall). Adjacent developments within this 20-foot envelope may be required to submit a Threat Assessment and Blast/Explosion Study for Metro review and approval.

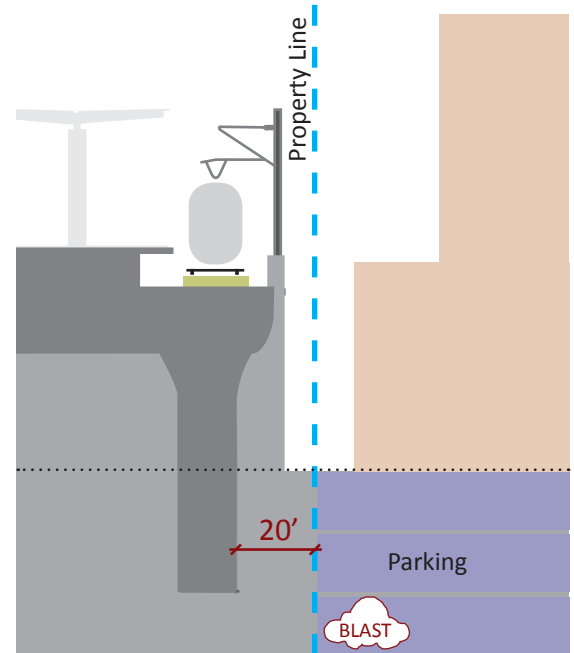

*An underground structure proposed within twenty (20) feet of a Metro structure may require a Threat Assessment and Blast/Explosion Study.*

**THIS PAGE INTENTIONALLY LEFT BLANK.**







# Construction Safety & Management

# Construction Safety & Management

## 3.1 Pre-Construction Coordination

Metro is concerned with impacts to service requiring rail single line tracking, line closures, speed restrictions, and bus bridging occurring as a result of adjacent project construction. Projects that will require work over, under, adjacent, or on Metro property or ROW and include operation of machinery, scaffolding, or any other potentially hazardous work are subject to evaluation in preparation for and during construction to maintain safe transit operations and passenger well-being.

**RECOMMENDATION:** Following an initial screening of the project, Metro may determine that additional on-site coordination may be necessary. Dependent on the nature of the adjacent construction, developers may be requested to perform the following as determined on a case-by-case basis:

- Submit a construction work plan and related project drawings and specifications for Metro review.
- Submit a contingency plan, show proof of insurance coverage, and issue current certificates.
- Provide documentation of contractor qualifications.
- Complete pre-construction surveys, perform baseline readings, and install movement instrumentation.
- Complete readiness review and perform practice run of transit service shutdown per contingency plan.
- Designate a ROW observer or other safety personnel and an inspector from the project's construction team.
- Establish a coordination process for access and work in or adjacent to ROW for the duration of construction.

**Project teams will be responsible for the costs of adverse impacts to Metro transit operations caused by work on adjacent developments, including remedial work to repair damage to Metro property, facilities, or systems.** Additionally, a Construction Monitoring fee may be assessed based on an estimate of required level of effort provided by Metro.

All projects adjacent to Metrolink infrastructure will require compliance with SCRRRA Engineering Standards and Guidelines.



*Metro may need to monitor development construction near Metro facilities.*



## 3.2 Track Access and Safety

Permission from Metro is required to enter Metro property for rail construction and maintenance along, above, or under Metro ROW as these activities can interfere with Metro utilities and service and pose a safety hazard to construction teams and transit riders. Track access is solely at Metro's discretion and is discouraged to prevent electrocution and collisions with construction workers or machines.

**RECOMMENDATION:** Obtain and/or complete the following to work in or adjacent to Metro Rail ROW:

1. **Construction Work Plan:** Dependent on the nature of adjacent construction, Metro may request a construction work plan, which describes means and methods and other construction plan details, to ensure the safety of transit operators and riders.
2. **Safety Training:** All members of the project construction team will be required to attend Metro Rail Safety Training before commencing work activity. Training provides resources and procedures when working near active rail ROW.
3. **Right of Entry Permit/Temporary Construction Easement:** All access to and activity on Metro property, including easements necessary for construction of adjacent projects, must be approved through a Right-of-Entry Permit and/or a Temporary Construction Easement obtained from Metro Real Estate and may require a fee.
4. **Track Allocation:** All work on Metro Rail ROW must receive prior approval from Metro Rail Operations Control. Track Allocation identifies, reserves, and requests changes to normal operations for a specific track section, line, station, location, or piece of equipment to allow for safe use by a non-Metro entity. If adjacent construction is planned in close proximity to active ROW, flaggers must be used to ensure safety of construction workers and transit riders.



*Trained flaggers ensure the safe crossing of pedestrians and workers of an adjacent development.*

# Construction Safety & Management

## 3.3 Construction Hours

Building near active Metro ROW poses safety concerns and may require limiting hours of construction which impact Metro ROW to night or off-peak hours so as not to interfere with Metro revenue service. To maintain public safety and access for Metro riders, construction should be planned, scheduled, and carried out in a way to avoid impacts to Metro service and maintenance.

**RECOMMENDATION:** In addition to receiving necessary construction approvals from the local jurisdiction, all construction work on or in close proximity to Metro ROW must be scheduled through the Track Allocation Process, detailed in Section 3.2.

Metro prefers that adjacent construction with potential to impact normal, continuous Metro operations take place during non-revenue hours (approximately 1am-4am) or during non-peak hours to minimize impacts to service. The developer may be responsible for additional operating costs resulting from disruption to normal Metro service.

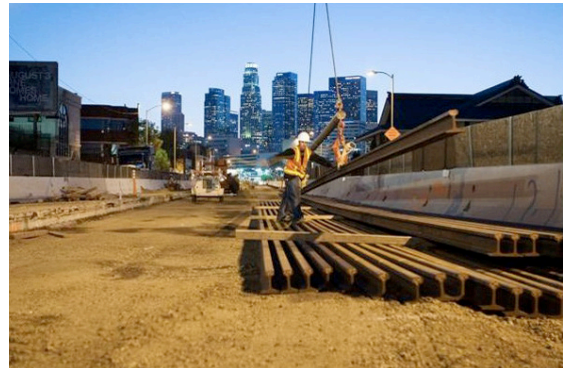

*Construction during approved hours ensures the steady progress of adjacent development construction and minimizes impacts to Metro's transit service.*



### 3.4 Excavation/Drilling Monitoring

Excavation is among the most hazardous construction activities and can pose threats to the structural integrity of Metro’s transit infrastructure.

**RECOMMENDATION:** Coordinate with Metro Engineering to review and approve excavation and shoring plans during design and development, and well in advance of construction (see Sections 2.1 and 2.2).

Geotechnical instrumentation and monitoring will be required for all excavations occurring within Metro’s geotechnical zone of influence, where there is potential for adversely affecting the safe and efficient operation of transit vehicles. Monitoring of Metro facilities due to adjacent construction may include the following as determined on a case-by-case basis:

- Pre- and post-construction condition surveys
- Extensometers
- Inclinometers
- Settlement reference points
- Tilt-meters
- Groundwater observation wells
- Movement arrays
- Vibration monitoring



*Excavation and shoring plans must be reviewed by Metro to ensure structural compatibility with Metro infrastructure and safety during adjacent development construction.*

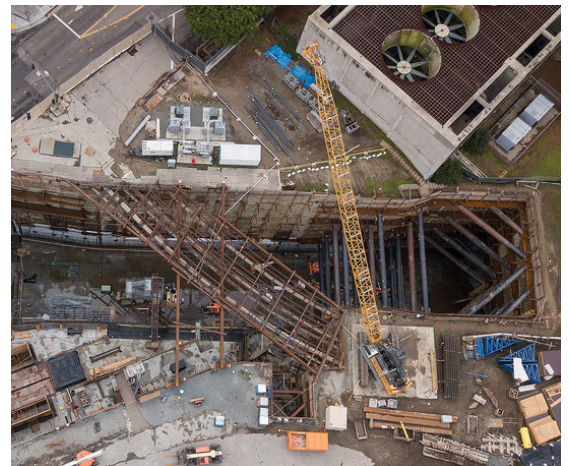

*A soldier pile wall used for Regional Connector station at 2nd/Hope.*

# Construction Safety & Management

## 3.5 Crane Operations

Construction activities adjacent to Metro ROW will often require moving large, heavy loads of building materials and machinery by crane. Cranes referred to in this section include all power operated equipment that can hoist, lower, and horizontally move a suspended load. There are significant safety issues to be considered for the operators of crane devices as well as Metro riders and operators.

**RECOMMENDATION:** Per California Occupational Safety and Health Administration (Cal/OSHA) standards, cranes shall maintain a 20 foot clearance from Metro OCS used to power light rail lines. In the event that a crane or its load needs to enter the 20-foot envelope, OCS lines must be de-energized. De-energizing the Metro OCS is strongly discouraged.

Construction activities which involve swinging a crane and suspended loads over Metro facilities or bus passenger areas shall not be performed during revenue hours. The placement and swing of this equipment are subject to Metro review of a construction work plan request.

**Project teams will bear all costs associated with impacts to Metro Rail operations and maintenance.**

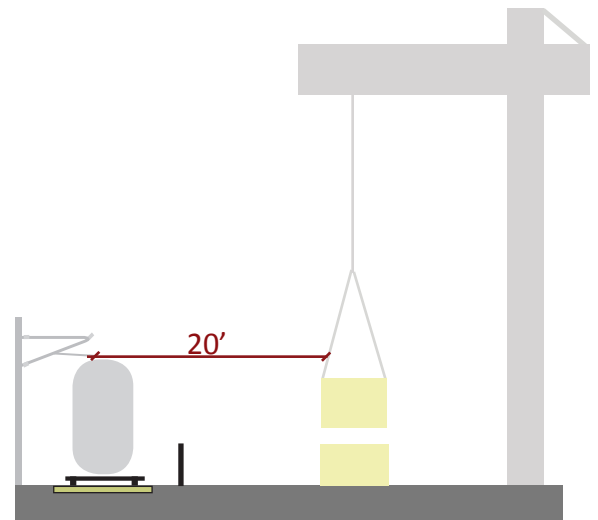

*Cranes and construction equipment should be staged to avoid conflicts with the rail OCS.*



*Construction adjacent to the active ROW may require ongoing coordination with Metro.*



### 3.6 Construction Barriers & Overhead Protection

During construction, falling objects can damage Metro facilities and pose a safety concern to the riders accessing them.

**RECOMMENDATION:** Erect vertical construction barriers and overhead protection compliant with Metro and Cal/OSHA requirements to prevent objects from falling into Metro ROW or areas designed for public access to Metro facilities. A protection barrier shall be constructed to cover the full height of an adjacent project and overhead protection from falling objects shall be provided over Metro ROW as necessary. Erection of the construction barriers and overhead protection for these areas shall be done during Metro non-revenue hours.



*Overhead protection is required when moving heavy objects over Metro ROW or in areas designated for public use.*



# Construction Safety & Management

## 3.7 Pedestrian & Emergency Access

Metro's riders rely on the consistency and reliability of access and wayfinding to and from stations, stops, and facilities. Construction on adjacent property must not obstruct pedestrian access, fire department access, emergency egress, or otherwise present a safety hazard to Metro operations, its employees, riders, and the general public. Fire access and safe escape routes within all Metro stations, stops, and facilities must be maintained at all times.

**RECOMMENDATION:** Ensure pedestrian and emergency access from Metro stations, stops, and transit facilities is compliant with the Americans with Disabilities Act (ADA) and maintained during construction:

- Temporary fences, barricades, and lighting should be installed and watchmen provided for the protection of public travel, the construction site, adjacent public spaces, and existing Metro facilities.
- Temporary signage should be installed where necessary and in compliance with the latest California Manual on Uniform Traffic Control Devices (MUTCD) and in coordination with Metro Art and Design Standards.
- Emergency exits shall be provided and be clear of obstructions at all times.
- Access shall be maintained for utilities such as fire hydrants, stand pipes/connections, and fire alarm boxes as well as Metro-specific infrastructure such as fan and vent shafts.



*Sidewalk access is blocked for a construction project, forcing pedestrians into the street or to use less direct paths to the Metro facility.*



### 3.8 Impacts to Bus Routes & Stops

During construction, bus stop zones and routes may need to be temporarily relocated. Metro needs to be informed of activities that require stop relocation or route adjustments in order to ensure uninterrupted service.

**RECOMMENDATION:** During construction, maintain or relocate existing bus stops consistent with the needs of Metro Bus Operations. Design of temporary and permanent bus stops and surrounding sidewalk areas must be compliant with the ADA and allow passengers with disabilities a clear path of travel to the transit service. Existing bus stops must be maintained as part of the final project. Metro Bus Operations Control Special Events Department and Metro Stops & Zones Department should be contacted at least 30 days before initiating construction activities.



*Temporary and permanent relocation of bus stops and layover zones will require coordination between developers, Metro, and other municipal bus operators and local jurisdictions.*

# Construction Safety & Management

## 3.9 Utility Coordination

Construction has the potential to interrupt utilities that Metro relies on for safe operations and maintenance. Utilities of concern to Metro include, but are not limited to, condenser water piping, potable/fire water, storm and sanitary sewer lines, and electrical/telecommunication services.

**RECOMMENDATION:** Coordinate with Metro during project design to gauge temporary and permanent utility impacts and avoid conflicts during construction.

The contractor shall protect existing above-ground and underground Metro utilities during construction and coordinate with Metro to receive written approval for any utilities pertinent to Metro facilities that may be used, interrupted, or disturbed.

When electrical power outages or support functions are required, approval must be obtained through Metro Track Allocation in coordination with Metro Real Estate for a Right of Entry Permit.



*Coordination of underground utilities is critical to safely and efficiently operate Metro service.*



### 3.10 Air Quality & Ventilation Protection

Hot or foul air, fumes, smoke, steam, and dust from adjacent construction activities can negatively impact Metro facilities, service, and users.

**RECOMMENDATION:** Ensure that hot or foul air, fumes, smoke, and steam from adjacent facilities are discharged beyond 40 feet from existing Metro facilities, including but not limited to ventilation system intake shafts and station entrances. Should fumes be discharged within 40 feet of Metro intake shafts, a protection panel around each shaft shall be required.



*A worker breaks up concrete creating a cloud of silica dust.*

# Glossary

## **Cone of Visibility**

A conical space at the front of moving transit vehicles allowing for clear visibility of travel way and/or conflicts.

## **Construction Work Plan (CWP)**

Project management document outlining the definition of work tasks, choice of technology, estimation of required resources and duration of individual tasks, and identification of interactions among the different work tasks.

## **Flagger/Flagman**

Person who controls traffic on and through a construction project. Flaggers must be trained and certified by Metro Rail Operations prior to any work commencing in or adjacent to Metro ROW.

## **Geotechnical Foul Zone**

Area below a track-way as measured from a 45-degree angle from the edge of the rail track ballast.

## **Guideway**

A channel, track, or structure along which a transit vehicle moves.

## **Heavy Rail Transit (HRT)**

Metro HRT systems include exclusive ROW (mostly subway) trains up to six (6) cars long (450') and utilize a contact rail for traction power distribution (e.g. Metro Red Line).

## **Joint Development (JD)**

JD is the asset management and real estate development program through which Metro collaborates with developers to build housing, retail, and other amenities on Metro properties near transit, typically through ground lease. JD projects directly link transit riders with destinations and services throughout LA County.

## **Light Rail Transit (LRT)**

Metro LRT systems include exclusive, semi-exclusive, or street ROW trains up to three (3) cars long (270') and utilize OCS for traction power distribution (e.g. Metro Blue Line).

## **Measure R**

Half-cent sales tax for LA County approved in November 2008 to finance new transportation projects and programs. The tax expires in 2039.

## **Measure M**

Half-cent sales tax for LA County approved in November 2016 to fund transportation improvements, operations and programs, and accelerate projects already in the pipeline. The tax will increase to one percent in 2039 when Measure R expires.

## **Metrolink**

A commuter rail system with seven lines throughout Los Angeles, Orange, Riverside, San Bernardino, Ventura, and North San Diego counties governed by the Southern California Regional Rail Authority (SCRRA).

## **Metro Adjacent Construction Design Manual**

Volume III of the Metro Design Criteria & Standards, which outlines the Metro adjacent review procedure as well as operational requirements when constructing over, under, or adjacent to Metro facilities, structures, and property.

## **Metro Bus**

Metro "Local" and "Rapid" bus service runs within the street, typically alongside vehicular traffic, though occasionally in "bus-only" lanes.

## **Metro Bus Rapid Transit (BRT)**

High quality bus service that provides faster and convenient service through the use of dedicated ROW, branded vehicles and stations, high frequency and intelligent transportation systems, all-door boarding, and intersection crossing priority. Metro BRT may run within dedicated ROW or in mixed flow traffic on streets.

**Metro Design Criteria and Standards**

A compilation of documents that govern how Metro transit service and facilities are designed, constructed, operated, and maintained.

**Metro Rail**

Urban rail system serving LA County consisting of six lines, including two subway lines and four light rail lines.

**Metro Rail Design Criteria (MRDC)**

Volume IV of the Metro Design Criteria & Standards which establishes design criteria for preliminary engineering and final design of a Metro Rail Project.

**Metro Transit Oriented Communities**

Land use planning and community development program that seeks to maximize access to transportation as a key organizing principle and promote equity and sustainable living by offering a mix of uses close to transit to support households at all income levels, as well as building densities, parking policies, urban design elements, and first/last mile facilities that support ridership and reduce auto dependency.

**Noise Easement Deed**

Easement granted by property owners abutting Metro ROW acknowledging noise due to transit operations and maintenance.

**Overhead Catenary System (OCS)**

One or more electrified wires situated over a transit ROW that transmit power to light rail trains via pantograph, a current collector mounted on the roof of an electric vehicle. Metro OCS is supported by hollow poles placed between tracks or on the outer edge of parallel tracks.

**Right of Entry Permit**

Written approval granted by Metro Real Estate to enter Metro ROW and property.

**Right of Way (ROW)**

Legal right over property reserved for transportation purposes to construct, protect, maintain and operate transit services.

**Southern California Regional Rail Authority (SCRRA)**

A joint powers authority made up of an 11-member board representing the transportation commissions of Los Angeles, Orange, Riverside, San Bernardino and Ventura counties. SCRRA governs and operates Metrolink service.

**Threat Assessment and Blast/Explosion Study**

Analysis performed when adjacent developments are proposed within twenty (20) feet from an existing Metro tunnel or facility.

**Track Allocation/Work Permit**

Permit granted by Metro Rail Operations Control to allocate a section of track and perform work on or adjacent to Metro Rail ROW. This permit should be submitted for any work that could potentially foul the envelope of a train.

**Wayfinding**

Signs, maps, and other graphic or audible methods used to convey location and directions to travelers.

[metro.net/projects/devreview/](http://metro.net/projects/devreview/)





Los Angeles County  
Metropolitan Transportation Authority

One Gateway Plaza  
Los Angeles, CA 90012-2952

213.922.2000 Tel  
metro.net

**Metro**

June 1, 2020

Mindy Nguyen  
City of Los Angeles, Department of City Planning  
221 North Figueroa Street, Suite 1350  
Los Angeles, CA 90012  
Sent by Email: mindy.nguyen@lacity.org

RE: Hollywood Center Project: ENV-2018-2115-EIR  
Draft Environmental Impact Report (DEIR) - Metro Comments

Dear Ms. Nguyen:

Thank you for coordinating with the Los Angeles County Metropolitan Transportation Authority (Metro) regarding the proposed Hollywood Center Project (Project) located at 1720-1724 North Vine Street in the City of Los Angeles (City). Metro is committed to working with local municipalities, developers, and other stakeholders across Los Angeles County on transit-supportive developments to grow ridership, reduce driving, and promote walkable neighborhoods. Transit Oriented Communities (TOCs) are places (such as corridors or neighborhoods) that, by their design, allow people to drive less and access transit more. TOCs maximize equitable access to a multi-modal transit network as a key organizing principle of land use planning and holistic community development.

Per Metro's area of statutory responsibility pursuant to sections 15082(b) and 15086(a) of the Guidelines for Implementation of the California Environmental Quality Act (CEQA: Cal. Code of Regulations, Title 14, Ch. 3), the purpose of this letter is to provide the City with information on potential synergies associated with transit-oriented developments that should be considered in the Environmental Impact Report (EIR) for the Project.

In addition to the specific comments outlined below, Metro is providing the City and MCAF Vine LLC, 1750 North Vine LLC, 1749 North Vine Street LLC, 1770 Ivar LLC, 1722 North Argyle LLC, and 1720 North Vine LLC (Applicant) with the Metro Adjacent Development Handbook (attached), which provides an overview of common concerns for development adjacent to Metro right-of-way (ROW) and transit facilities, available at [www.metro.net/projects/devreview/](http://www.metro.net/projects/devreview/).

**Project Description**

The Project includes a mixed-use development on an approximately 4.46-acre site, generally bounded by Yucca Street on the north, Ivar Avenue on the west, Argyle Avenue on the east, and adjacent development and Hollywood Boulevard on the south, and bifurcated by Vine Street. Under the Project, the existing building on the West Site would be demolished and the Capitol Records Complex would be preserved, and the remainder of the Project Site would be redeveloped with 1,005 residential units, comprised 872 market-rate and 133 senior affordable units, and up to 30,176 square feet of commercial uses, within four new mixed-use buildings (West Building, East Building, West Senior Building, East Senior Building) which range in height from 11 to 46 stories.



### Transit Supportive Planning: Recommendations and Resources

Considering the Project's proximity to the Hollywood/Vine Station, Metro would like to identify the potential synergies associated with transit-oriented development:

1. Transit Supportive Planning Toolkit: Metro strongly recommends that the Applicant review the Transit Supportive Planning Toolkit which identifies 10 elements of transit-supportive places and, applied collectively, has been shown to reduce vehicle miles traveled by establishing community-scaled density, diverse land use mix, combination of affordable housing, and infrastructure projects for pedestrians, bicyclists, and people of all ages and abilities. This resource is available at <https://www.metro.net/projects/tod-toolkit>.
2. Land Use: Metro supports development of commercial and residential properties near transit stations and understands that increasing development near stations represents a mutually beneficial opportunity to increase ridership and enhance transportation options for the users of developments. Metro encourages the City and Applicant to be mindful of the Project's proximity to the Hollywood and Vine Station, including orienting pedestrian pathways towards the station.
3. Transit Connections and Access: Metro strongly encourages the Applicant to install Project features that help facilitate safe and convenient connections for pedestrians, people riding bicycles, and transit users to/from the Project site and nearby destinations. The City should consider requiring the installation of such features as part of the conditions of approval for the Project, including:
  - a. Walkability: The provision of wide sidewalks, pedestrian lighting, a continuous canopy of shade trees, enhanced crosswalks with ADA-compliant curb ramps, and other amenities along all public street frontages of the development site to improve pedestrian safety and comfort to access the nearby Hollywood/Vine Station.
  - b. Transfer Activity: Given the Project's proximity to the Metro Hollywood and Vine Station the Project design should consider and accommodate transfer activity between bus and (bus or rail) lines that will occur along the sidewalks and public spaces. Metro has completed the Metro Transfers Design Guide, a best practices document on transit improvements. This can be accessed online at <https://www.metro.net/projects/systemwidedesign>.
  - c. Bicycle Use and Micromobility Devices: The provision of adequate short-term bicycle parking, such as ground-level bicycle racks, and secure, access-controlled, enclosed long-term bicycle parking for residents, employees, and guests. Bicycle parking facilities should be designed with best practices in mind, including highly visible siting, effective surveillance, ease to locate, and equipment installation with preferred spacing dimensions, so bicycle parking can be safely and conveniently accessed. Similar provisions for micro-mobility devices are also encouraged. The Applicant should also coordinate with the Metro Bike Share program for a potential Bike Share station at this development.
  - d. First & Last Mile Access: The Project should address first-last mile connections to transit and is encouraged to support these connections with wayfinding signage inclusive of all modes of transportation. For reference, please review the First Last Mile Strategic Plan, authored by Metro and the Southern California Association of Governments (SCAG), available on-line at: [http://media.metro.net/docs/sustainability\\_path\\_design\\_guidelines.pdf](http://media.metro.net/docs/sustainability_path_design_guidelines.pdf)
4. Parking: Metro encourages the incorporation of transit-oriented, pedestrian-oriented parking provision strategies such as the reduction or removal of minimum parking requirements and the exploration of shared parking opportunities. These strategies could be pursued to reduce automobile orientation in design and travel demand.

5. Wayfinding: Any temporary or permanent wayfinding signage with content referencing Metro services or featuring the Metro brand and/or associated graphics (such as Metro Bus or Rail pictograms) requires review and approval by Metro Signage and Environmental Graphic Design.
6. Transit Pass Programs: Metro would like to inform the Applicant of Metro's employer transit pass programs, including the Annual Transit Access Pass (A-TAP), the Employer Pass Program (E-Pass), and Small Employer Pass (SEP) Program. These programs offer efficiencies and group rates that businesses can offer employees as an incentive to utilize public transit. The A-TAP can also be used for residential projects. For more information on these programs, please visit the programs' website at <https://www.metro.net/riding/eapp/>.

If you have any questions regarding this letter, please contact me by phone at 213-922-2671, by email at [DevReview@metro.net](mailto:DevReview@metro.net), or by mail at the following address:

Metro Development Review  
One Gateway Plaza  
MS 99-22-1  
Los Angeles, CA 90012-2952

Sincerely,



Shine Ling, AICP  
Manager, Transit Oriented Communities

Attachments and links:

- Adjacent Development Handbook: <https://www.metro.net/projects/devreview/>